

MCOSMOS

SOFTWARE FOR 3D-CNC-
COORDINATE MEASURING MACHINES.

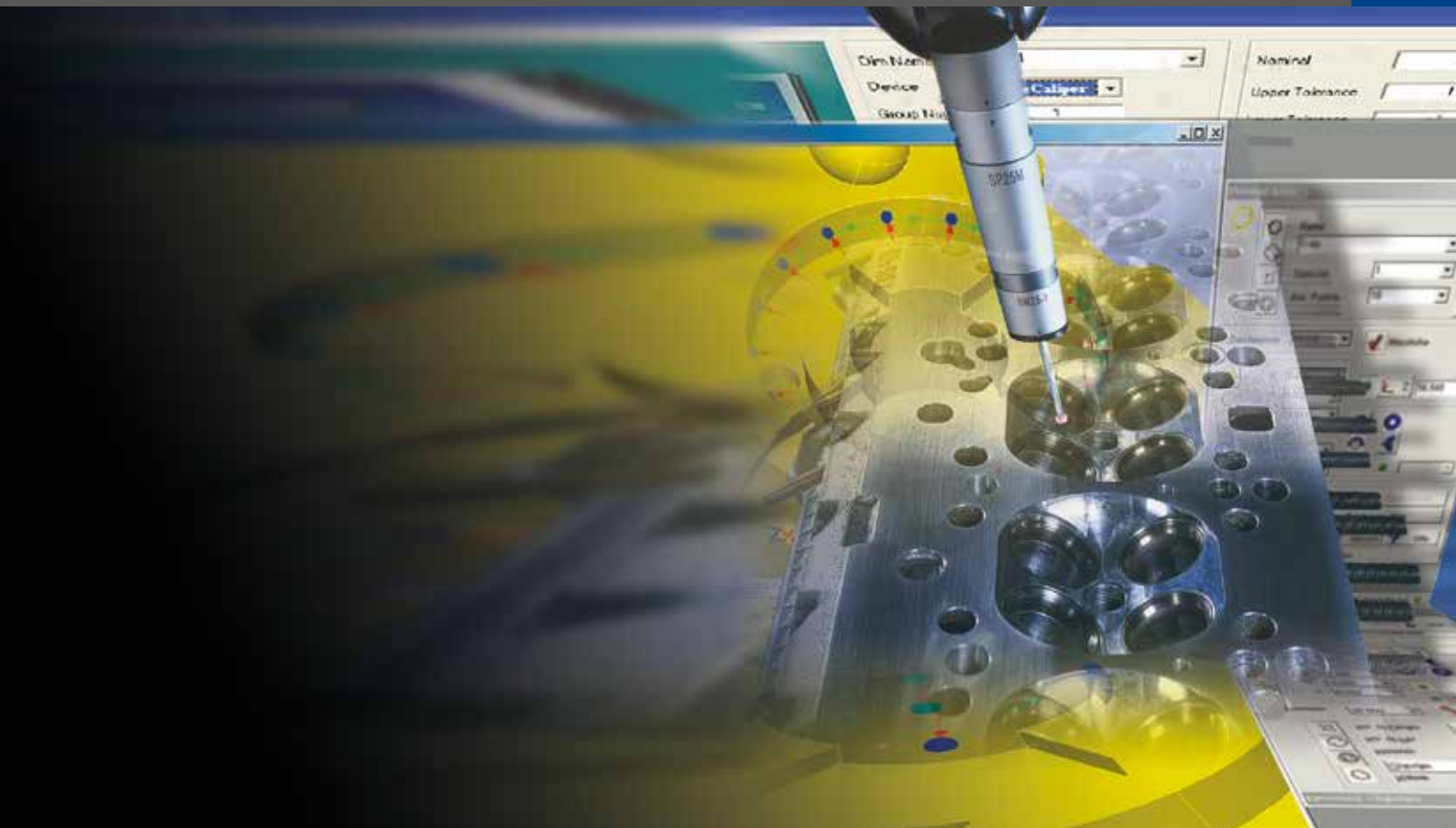

3D Coordinate Measuring Machines from Mitutoyo: A new dimension in quality assurance.

CMM SOFTWARE

MiCAT is the smart software platform from Mitutoyo, setting international standards for sophisticated 3D coordinate measurement. With MiCAT, your coordinate measuring machines become efficient information centres - power houses of design, production and quality control. Streamlined measurements and convenient and reliable data at your fingertips throughout the production process.

Our certified Computer Technology Laboratory (CTL) has developed MCOSMOS – the Mitutoyo Controlled Open System for Modular Operation Support. This is modular CMM software system giving professional measurement and evaluation.

MCOSMOS helps you carry out all your measuring and test jobs at lightning speed, simply and safely. MCOSMOS handles large amounts of data with ease, making it available across all the networked areas of the production chain. This streamlines the measuring process, optimises the flow of information and minimises non-conformances. The result is increased efficiency throughout the production process with significantly reduced costs.

With its specialist expansion modules, MCOSMOS can focus in on your company's very specific measurement requirements. With Mitutoyo software, you are best prepared for every imaginable 3D coordinate measurement challenge, both now and in the future, with maximum flexibility.

Mitutoyo: complete precision

Experience

Mitutoyo. Near to you, wherever you are.

Precision measurement technology with global dimensions.

With seven decades of experience, Mitutoyo is a pioneer and a pace-setter in precision measurement technology throughout the world. The Mitutoyo Group has spread out from its birthplace in Japan, and today has a presence in more than 100 countries in the world in the form of branches, factories and national distribution networks.

With this world-wide network, Mitutoyo has become an international leader in providing precision measurement technology from a single source. A claim based both on the quality of the 5000 plus Mitutoyo products and in a service philosophy that sets an example throughout the world.

In its certified Computer Technology Laboratory (CTL) in Oberndorf on the River Neckar in Germany, Mitutoyo employs highly qualified specialists who devote their expertise to developing software for 3D coordinate measurement technology, thereby setting world standards.



Software packages and expansion modules to meet every requirement

With this sophisticated modular software system developed by Mitutoyo, you will have the capabilities of a variety of software packages and expansion modules at your fingertips. They can make comprehensive measurement evaluations, document and present them in an effective form. The data is archived into clear, practical structures. Of course, all coordinate measuring machines come with their own software package as standard

Some of the features offered by our software packages



PartManager

Is the command centre that boots and manages the software package.
Includes: ProtocolDesigner, ProbeBuilder, DialogDesigner, user management, manager program (unmanned shift).



GEOPAK (Geometry module, online/offline)

For easy parts program generation (online/offline) for measuring geometrical elements.

Includes: high-speed scanning of control geometries for continuous scanning, contact measuring heads, rotary tables are supported as a fourth axis, user-defined dialog support (variable program creation) and flexible reporting.



CAT1000P* (Online/offline programming module)

For control geometry and uncomplicated parts program generation supported by the CAD model.

Includes: MachineBuilder, automatic traverse path generation (animated), collision control and simulation of complete parts programs.



CAT1000S* (3D freeform evaluation module)

For preparation of setpoint/actual value comparisons from CAD model free form surfaces and measuring points.

Includes: MachineBuilder, automatic traverse path generation (animated), collision control and flexible reporting.



SCANPAK (2D profile evaluation module)

For the scanning and evaluation of workpiece contours.

Includes: Supports single point and continuous scanning measuring heads, rotary tables as fourth axis, variable contour tolerances, best fit, digitised and flexible reporting.



* Standard CAD import interfaces: ACIS, STEP

Optional CAD import interfaces: CATIA V4, CATIA V5, Pro/E, Parasolid, Unigraphics, SolidWorks, Inventor, IGES und VDAFS

Professional

Modules for expanding our software packages

MCOSMOS 1

MCOSMOS 2

MCOSMOS 3



MeasurLink®
Statistical evaluation module.
Real-time data collection, network-capable SPC analysis.

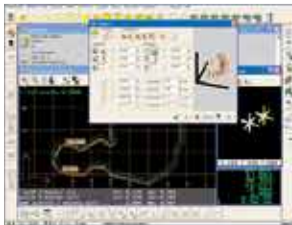

SCANPAK
For the scanning and evaluation of workpiece contours (2D).
Includes: Supports continuous scanning contact measuring heads, rotary table as a fourth axis, variable contour tolerances, best fit, patch scan (digitisation), flexible reporting.

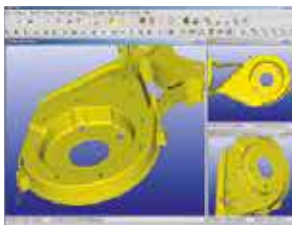

CAT10005
For the creation of desired/setpoint comparisons of freeform surfaces from the CAD model and measuring points.
Includes: MachineBuilder, automatic traverse path generation (animated), collision control and flexible reporting

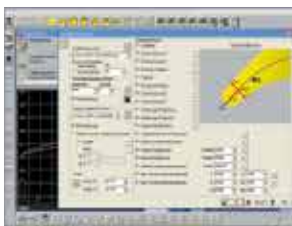

MAFIS
Bearing surface evaluation module.
For the analysis of selected characteristics of bearing surface profiles, supports flexible reporting

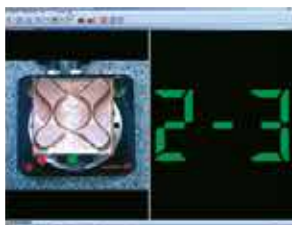

GEO_EDM
Online correction program for EDM tools and workpieces.



GEARPAK
Measuring module for involute gear profiles .
For the measurement of all types of involute gear profiles (spur, worm and bevel gears) and subsequent comparison with international and user-defined standards.

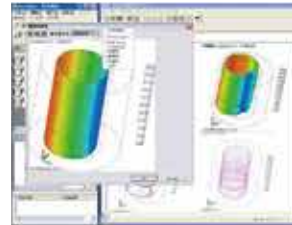

ROUNDPAK CMM
Extended evaluation functions for circles, cylinders, planes, straight lines and support for flexible reporting for the following parameters:

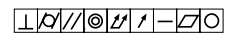

Pure DMISPAK
Interface module.
The interface for standard measuring equipment supports compatibility between various.



Correct Plus
NC compensation value module.
Optimised processing with feedback of correction data to the processing machine.



Q-PAK
Queuing program for sequence control of part programs, including loading system control.

PartManager. Control and command centre.

Standard module for: **MCOSMOS 1** **MCOSMOS 2** **MCOSMOS 3**

PartManager is the versatile management centre within MCOSMOS software, the control centre for all measurement tasks. From PartManager, boot main program modules such as GEOPAK, GEARPAK, CAT1000P/S etc. as well as all configuration programs such as MachineBuilder or DialogDesigner and ProtocolDesigner and user management. Here too, detailed documentation and archiving of data records are organised in a simple, convenient and very user-friendly way.



Use PartManager to organise all your notes, reports, data and images for any measurement process; clearly listed and assigned to each workpiece. A visible indicator is the parts list identifiable at first glance in the available data column. Longer part names and directories can be used. Click on the symbol and you can view the documents and start the programs you need. PartManager contains a user management system with a detailed system of user rights and revision management for measurement programs including change history. Here you have everything you need to comply with the German 21CFR Part 11 Directive.

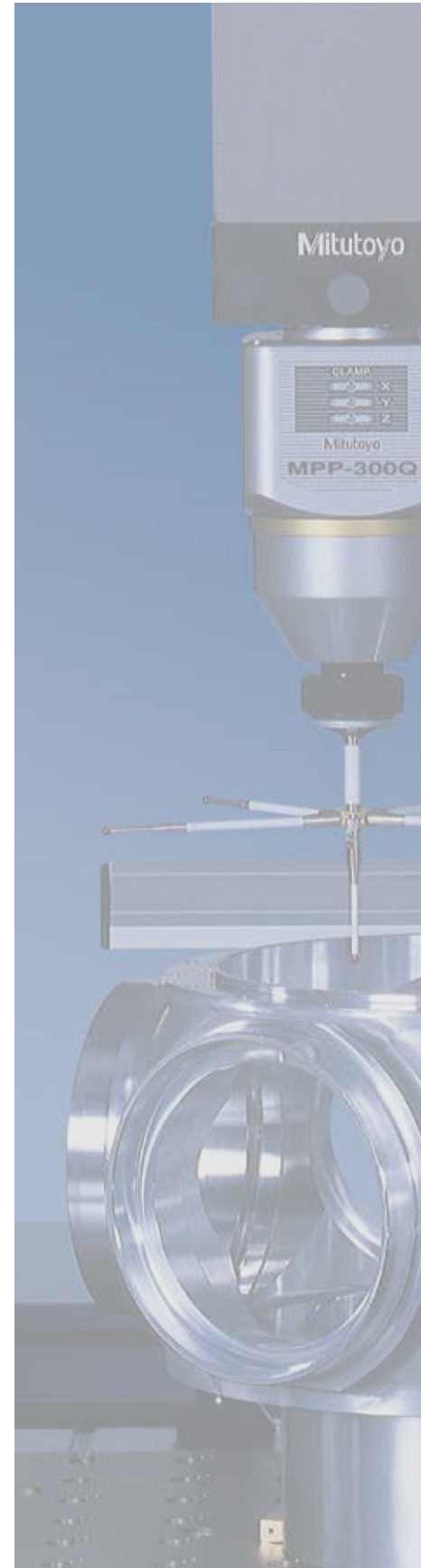

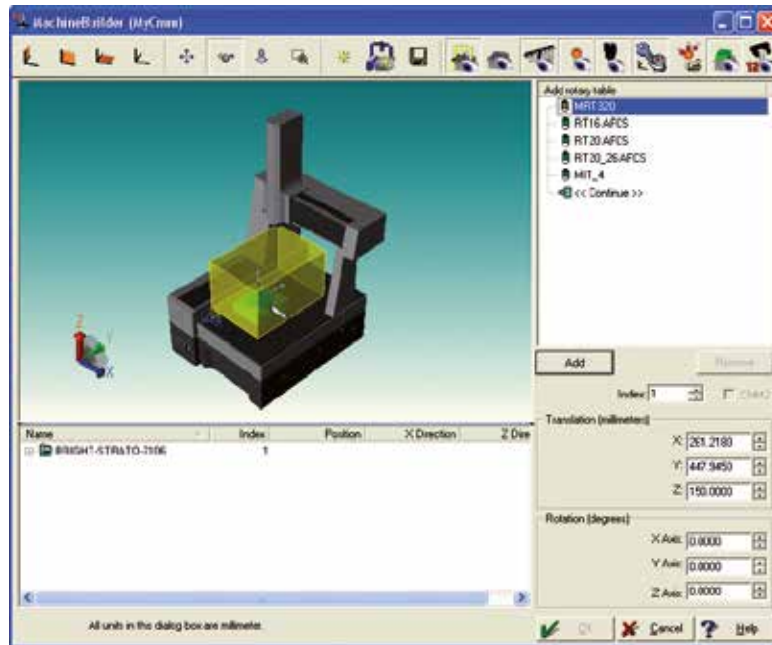

System manager

The system manager combines the former functions of the Machine Builder, the driver configuration and the change rack definition. As such, every single component comprising the periphery of the measuring device is clearly presented in one dialog, right up to probe configuration; all preconditions for simulating CNC workflows in CAT 1000.

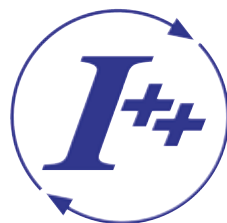

MCOSMOS is the modular software system for professional controlling, measuring and evaluation in coordinate measuring technology. MCOSMOS supports the I++ DME Interface (Dimensional Measurement Equipment Interface).

GEOPAK, the geometry module. Performance in the third dimension.

Standard module for: **MCOSMOS 1** **MCOSMOS 2** **MCOSMOS 3**

With the universal geometry measurement program for multidimensional measurement, you can control your workpiece from design to completion. Its multiple functions make GEOPAK one of the most powerful programs available, meeting the most stringent requirements, but very user friendly. For example, you can display step by step what exactly has to be done when aligning a workpiece. In addition to many dedicated reporting options, output on other systems (e.g. QS-Stat, Word, Excel) is also possible. In pallet mode, several workpieces of the same type can also be measured in unmanned operation. Further solutions to quite specific measuring tasks can be found in highly sophisticated hardware components such as various measuring heads, probe change systems, swivelling and turning links, rotary tables and clamping and loading systems, with many of which GEOPAK comes as standard.

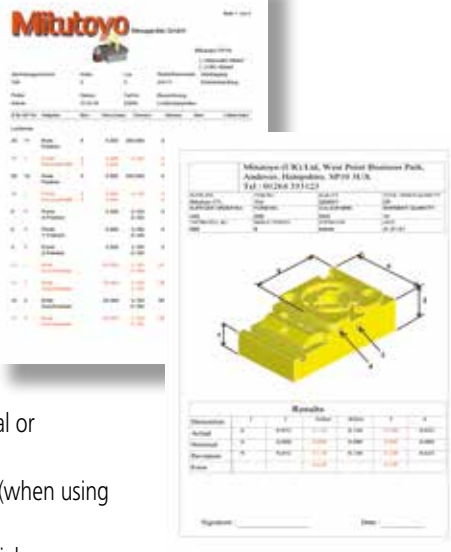
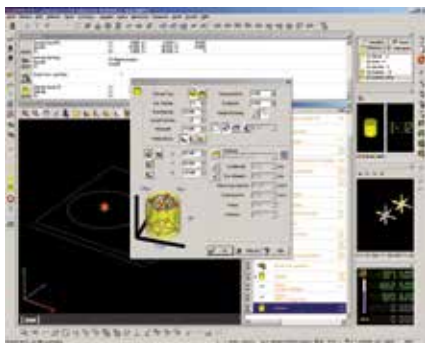

User-defined reports

GEOPAK means:

- Clear user guidance with menus and graphics
- Online/offline programming (in tutorial mode, virtual or editor mode)
- High-speed scanning of control geometry elements (when using continuous scanning measuring heads)
- Flexible programming by the use of user-definable dialogues and variables
- Support of rotary tables as 4th axis
- Revo® measuring head system is supported
- Use of various interchangeable measuring head systems (single point, continuous scanning laser measuring heads as well as sensors for image processing, including their associated change systems)
- Macros for automatic measurement of all control geometries
- Automatic element recognition
- Easy and rapid program correction (new tree structure in editor mode or in repeat mode)
- Integration of text, images and sound
- Flexible customer-specific reporting
- PTB-certified algorithms for geometry calculation



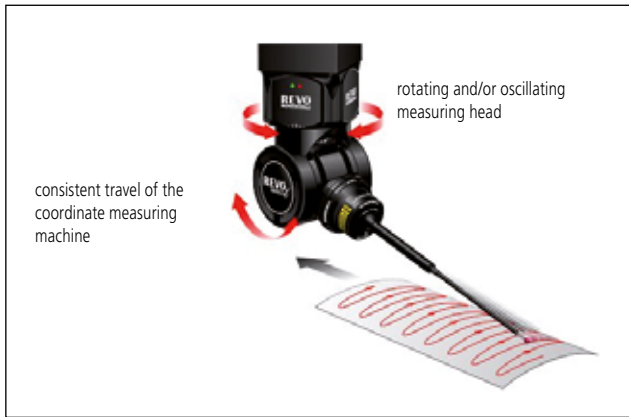
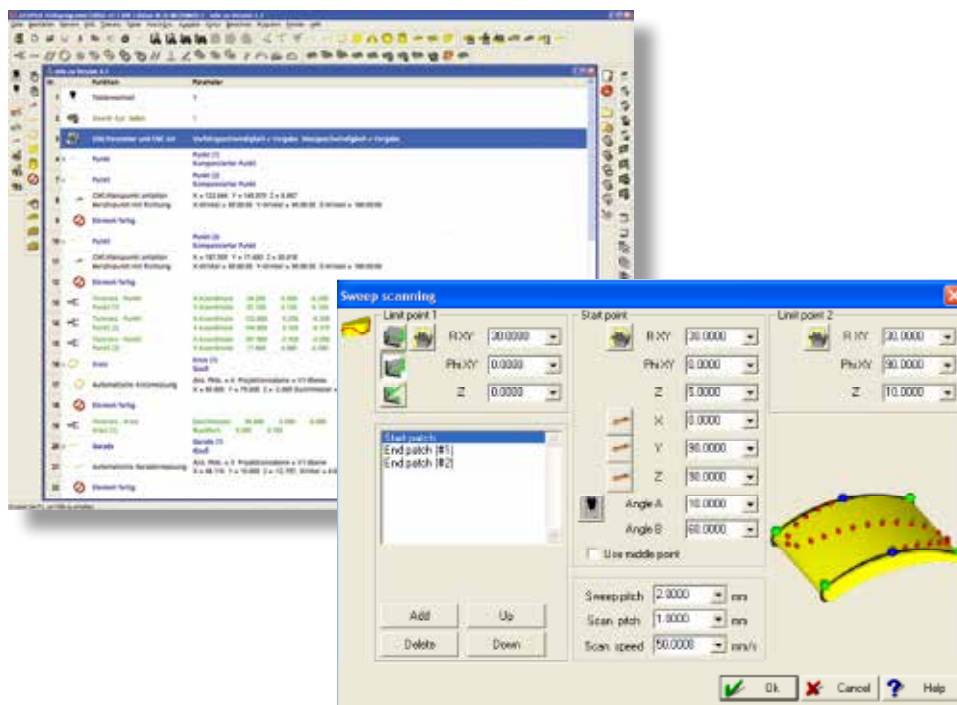

Revo® has a particularly efficient sweep scanning function for surfaces. The dialog learning function allows the function to be implemented even without a CAD model of the work piece

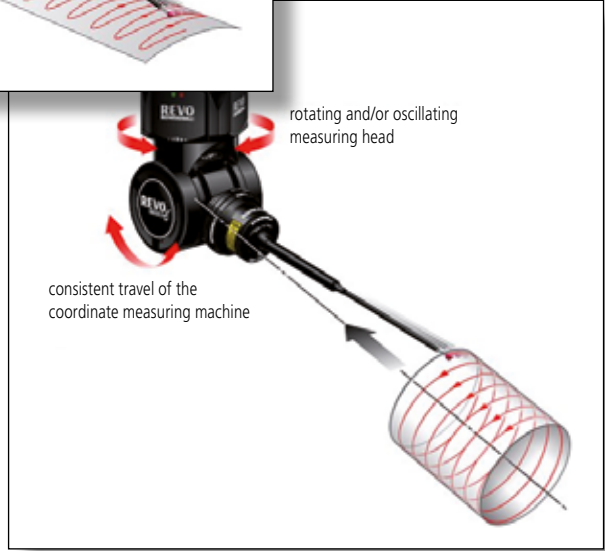

CAT1000P, the online/offline programming module. Easy programming from the CAD model.

Standard module for: **MCOSMOS 2** **MCOSMOS 3**
CNC CNC

CAT1000P puts an end to laborious data input. It significantly facilitates the programming of measurement tasks in GEOPAK tutorial mode. With just a few mouse clicks, all data for measuring parts and tolerance testing are taken from the CAD model – simply and safely. The same applies to the programming of traverse paths and probe points, and the creation of nominal values for setpoint/actual comparison. Travel and probe paths are clearly shown in a 3D view. They can be changed as desired at the click of the mouse on the model. Possible collisions are calculated in advance and reliably avoided. Probe changes can be automatically suggested. With the MachineBuilder (CSM), you can have a complete CMM workshop – from CMM and the probe change system right through to calibration balls. These configurations enable you to realistically simulate complete measuring programs.

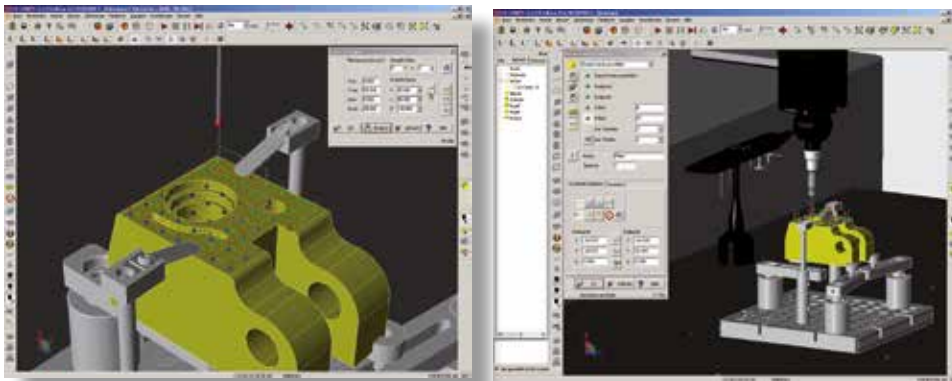

CAT1000P means:

- Simple measurement program creation from the CAD model (only for control geometry elements)
- Automatic probe changes are suggested
- Automatic traverse path generation and collision avoidance
- Clear representation of the measuring points in 3D graphics
- Automatic conversion of standard surfaces in the event of errors in the CAD model
- Simulation of individual traversing steps
- Simulation of complete parts programs
- Offline program creation for optimised machine use

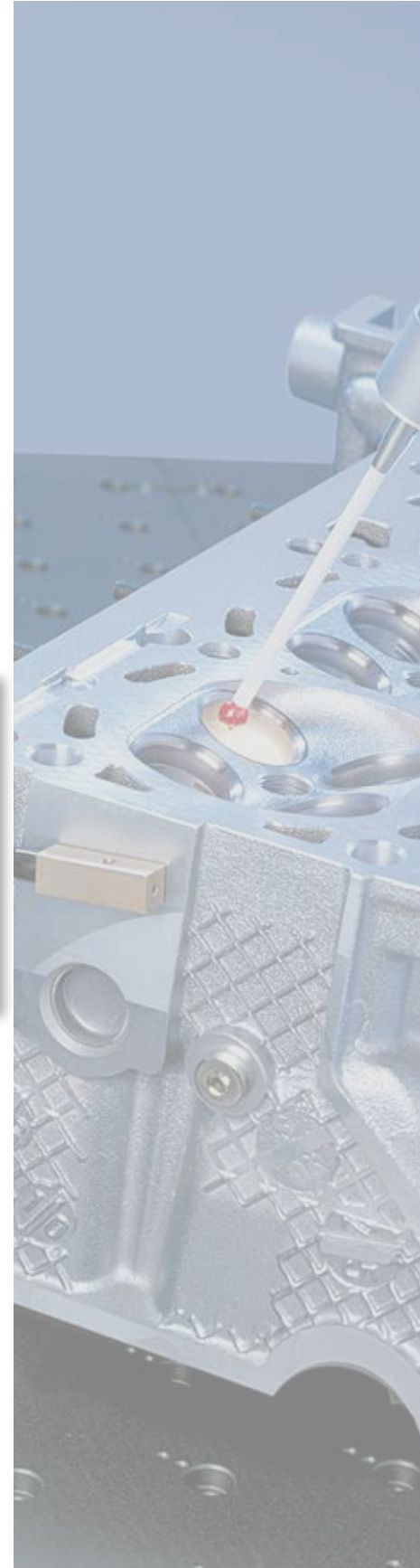

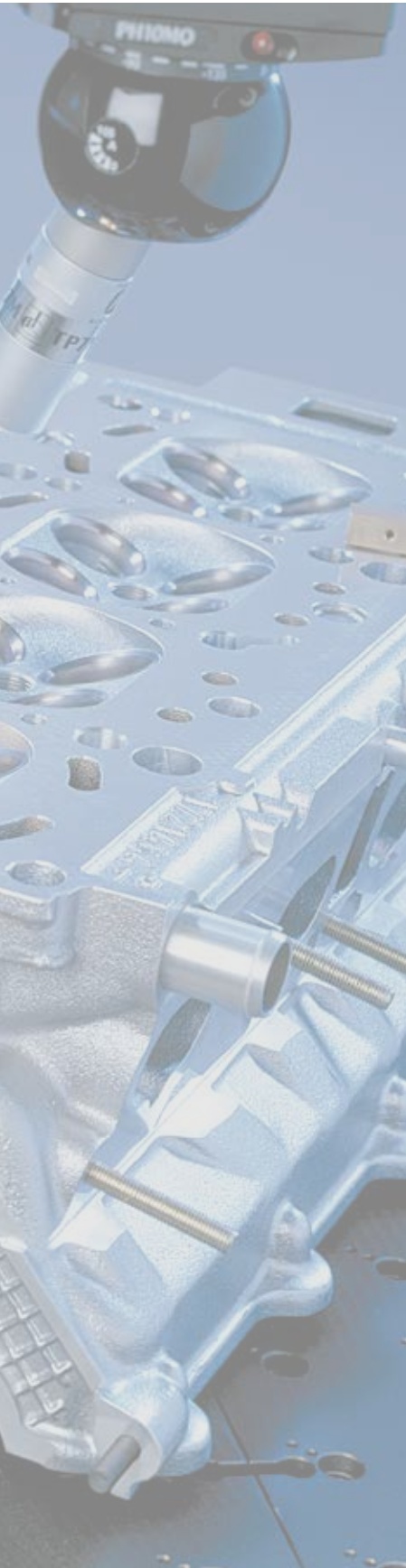

- Reading-in of standard interfaces ACIS (SAT) / STEP;
other direct interfaces as an option: CATIA V4/ CATIA V5 / Parasolid / Pro/E / Unigraphics / SolidWorks / Inventor / IGES / VDAFS)
- All interfaces for CAT1000P can also be used with CAT1000S
- Supports the following hole shape elements: solid circle, rectangle, square, triangle, trapezium, hexagon, elongated hole, teardrop

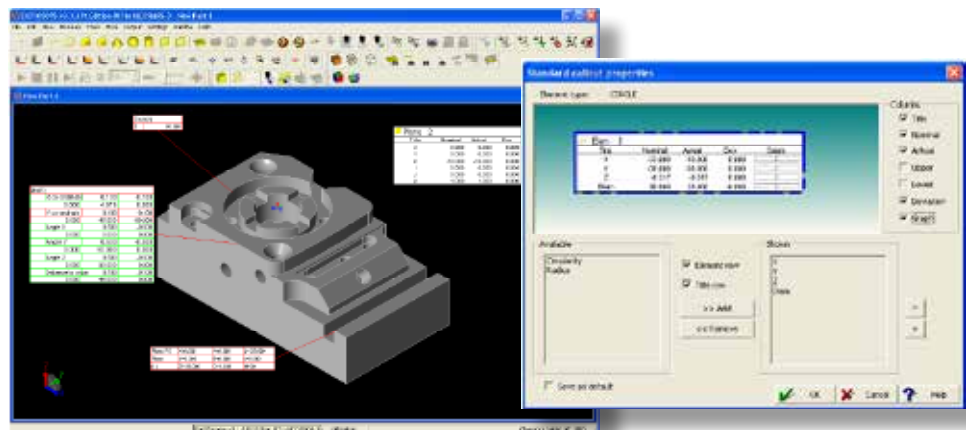

Information window editor

CAD model representation with information window containing the measurement results of the geometrical elements

GD & T (geometrical dimension and tolerancing):

GD & T Wizard: the assistant for CAD model-aided processing of dimensional and positional tolerances.

1) Tolerance assistant:

The tolerance assistant can be used for simplified analysis of tolerance information loaded via the CAD interfaces.

2) Tolerance definition assistant:

The tolerance definition assistant can be used to define tolerances and, as such, added to the CAD models where they are then available for further analysis.

Representation in accordance with ASME Y 14.41 standard

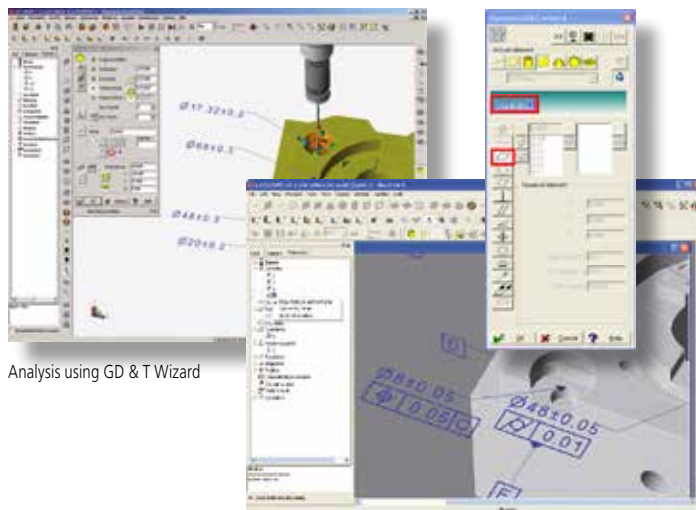

Analysis using GD & T Wizard

CAT1000S, the 3D freeform surface evaluation module. Tolerance comparison of freeform surfaces.

Standard module for: **MCOSMOS 2** **MCOSMOS 3**

CAT1000S shows its strengths in the precise comparison of solid bent surfaces with their desired setpoint entries from CAD data (e.g. bodywork parts). Individual measurement points can be allocated to the next surface or limited to one surface. The measurement results are represented as easy-to-interpret graphics, in which non-conformances are quickly and easily recognisable by colour marking. The cut edges of sheet metal parts can be precisely measured using CAT1000S. Animation and virtual representation of the next scanning process simplifies programming in tutorial mode.

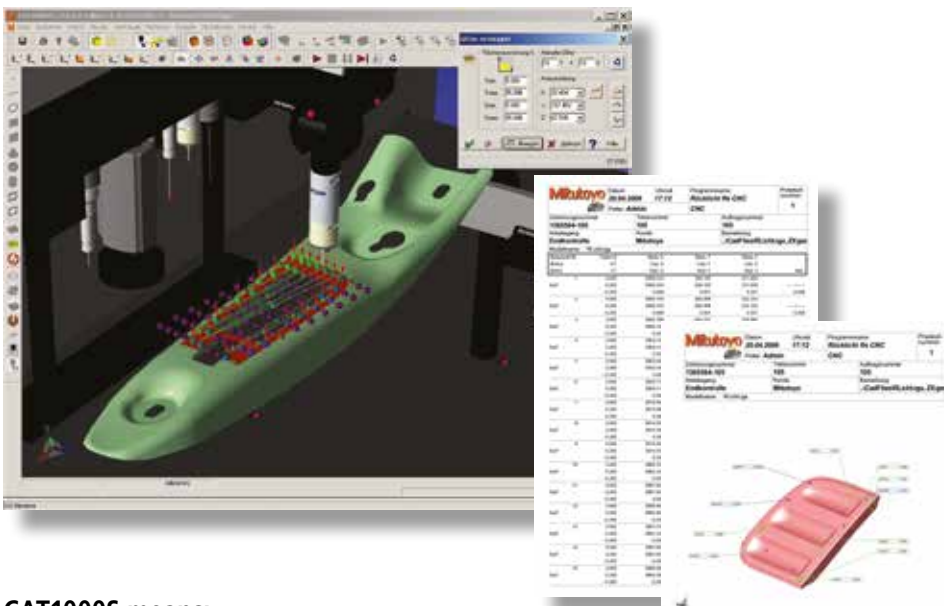

CAT1000S means:

- Simple, convenient operation
- Rapid setpoint/actual value comparison between setpoint entry and measurement
- Rotatable and scalable 3D representation
- Representation of non-conformances with colour graduations
- Best fit of measurement points on the CAD model
- Flexible, customer-specific reporting
- Reading-in of standard interfaces ACIS (SAT) / STEP; other direct interfaces as an option: CATIA V4 / CATIA V5 / Parasolid / Pro/E / Unigraphics / SolidWorks / Inventor / IGES / VDAFS)
- All interfaces for CAT1000P can also be used with CAT1000S

User-defined reports

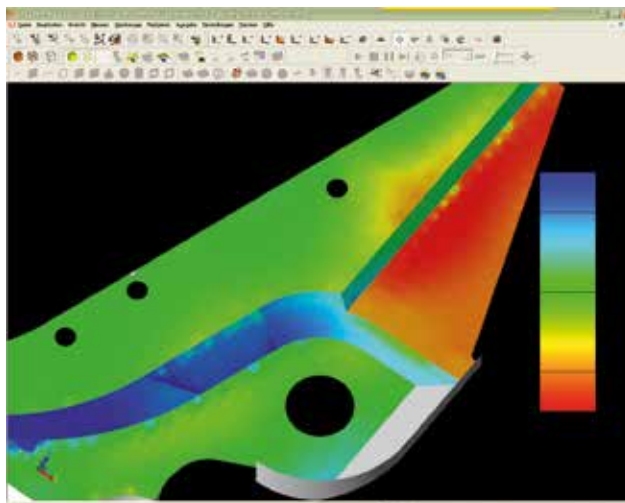

Surface quality can be represented as color shading on the CAD model surface using the topographic representation.



Curve scanning

CAT 1000S supports the scan function for continuous scanning of any types of contours using a Revo® measuring head. Movement can be easily programmed by mouse click on the CAD model, and virtually simulated.

MAFIS, the portable evaluation module. For soaring measurement skills.

Optional for: **MCOSMOS 3**

MAFIS stands for 'Mitutoyo Airfoil Inspection Software' and enables the calculation of all significant bearing surface parameters, e.g. of turbine blades on aeroplane engines or pump blades. It works in association with the MCOSMOS module SCANPAK, for the automatic scanning of workpiece forms. With SCANPAK the contour is first entered, after which in a separate menu the 'bearing surface analysis' can be selected for the evaluation of desired parameters. Using simple pictograms, all the necessary inputs can quickly be carried out. Outputting measured values is possible both in clear lists and graphs. All MAFIS parameters are supported by the MCOSMOS report designer with which individualised reports can be generated with ease.

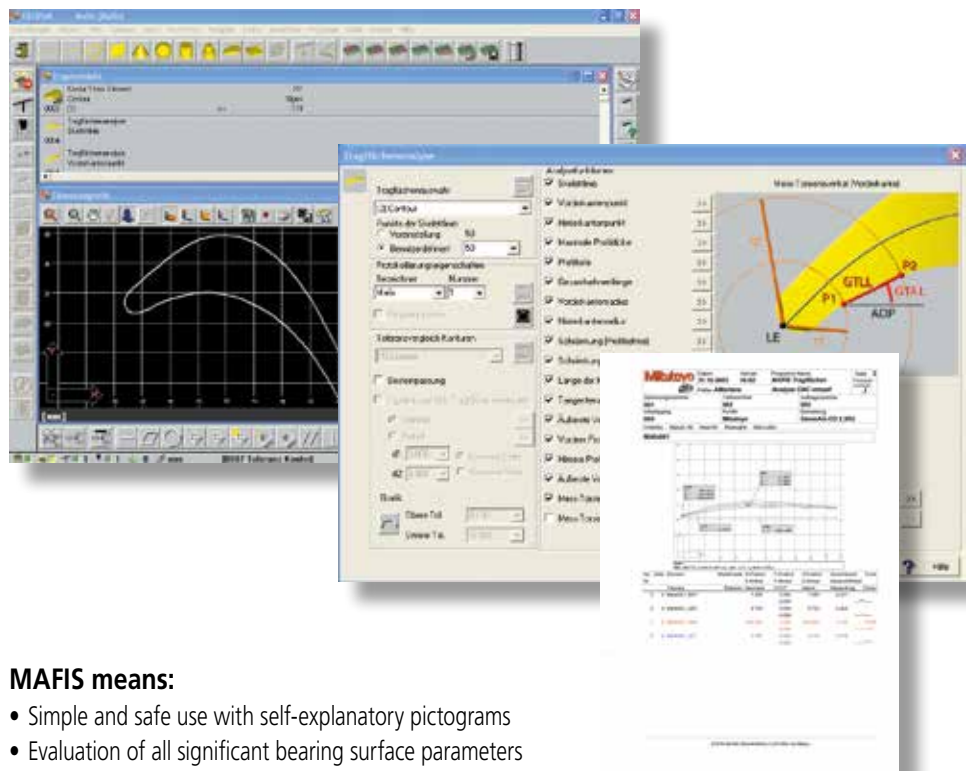

MAFIS means:

- Simple and safe use with self-explanatory pictograms
- Evaluation of all significant bearing surface parameters
- Support of all output functions of MCOSMOS (screen output, text output, ProtocolDesigner, MeasurLink)
- Contours can be entered using the SCANPAK expansion module

GEARPAK, the measurement module for involute gear profiles.

Quick and precise, inside and out.

GEARPAK is the MCOSMOS module specialising in measurement and evaluation of involute gear profiles. It is used for the rapid generation of measurement programs and creates evaluations and reports. GEARPAK was certified in 2005 by the Physikalisch Technischen Bundesanstalt (PTB). The results of the test data records deviated by less than $0.1 \mu\text{m}$ from the PTB's reference values – an impressive achievement. The measuring process is by single-point entry or scanning. The range of evaluations includes, in addition to complex gear flank evaluation for profile and flank line (including curvatures and reliefs), also pitch, concentricity, best fit and single and dual flank rolling test. The parameters to be included in the report are determined by the user, with numerical or graphic representation, or a combination of the two being possible.

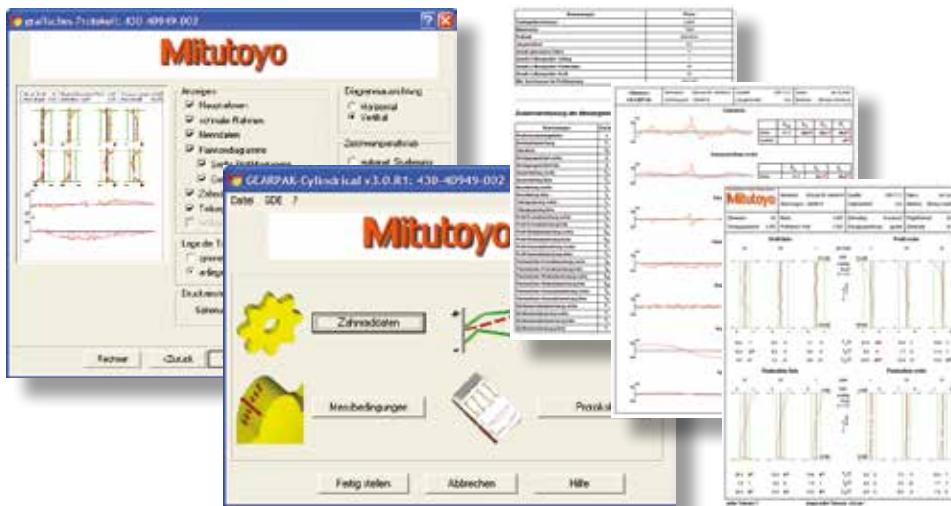

GEARPAK means:

- Rapid, safe and fully automatic creation of CNC measurement sequences for involute gear profiles (straight and inclined gears)
- Precise evaluation (certified by the PTB)
- Measurement and evaluation according to current standards and tolerance systems (DIN, ISO, AGMA etc.) and customer-specific tolerance tables
- Clearly structured dialogues and functions
- Dialogues for profile and flank line modification (reliefs, curvatures)
- Simple, menu-assisted data input with graphic feedback (self-explanatory pictograms)
- Graphic, numerical and combined reports
- Reports in HTML format

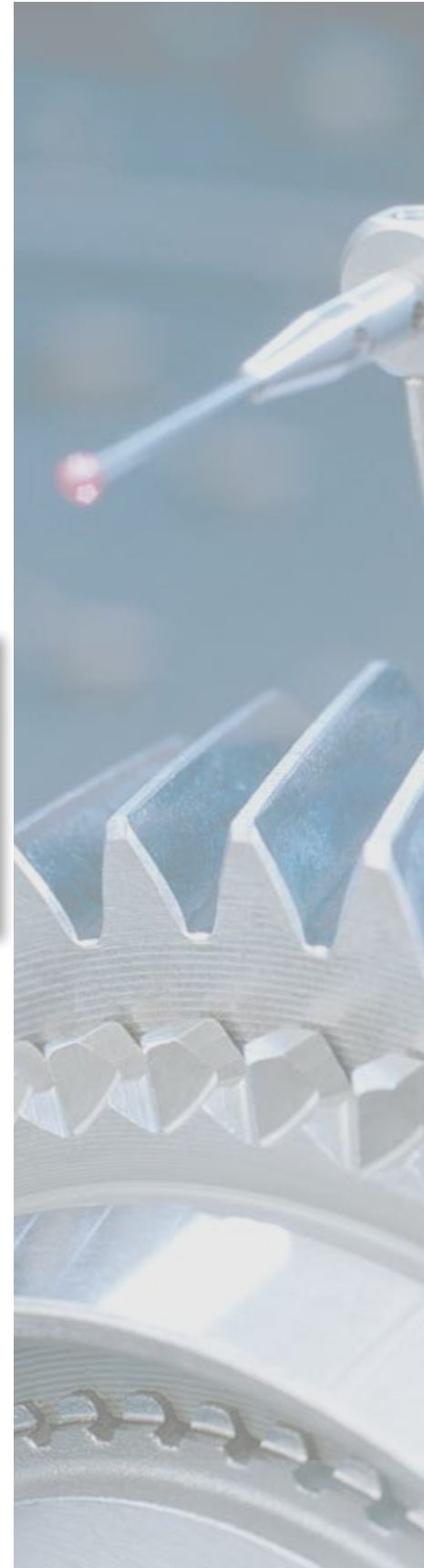

Pure DMISPAK, the interface module. Import, convert and export with ease.

The optional expansion module Pure DMISPAK serves as a powerful conversion tool when importing DMIS programs for further use in MCOSMOS. Vice versa, of course, Pure DMISPAK also ensures easy exporting of MCOSMOS programs into DMIS format.



```

Pure DMISPAK V3.002 (Oct. 20, 2005) B1 [Test.dmi]
File Edit Parameter View Conversion Jump Edit ASCII File Help
$$$
$$$ Translated by DMISOut v3.0.0, Build Date: 10/25/05
$$$ From MCOSMOS v3.0 Mitutoyo Corporation
$$$
$$$ Translated Date/Time : 11/22/05 11:02
$$$ GEOPAK Input File : D:\Mitutoyo\MCOSMOS\DATA\PV5N7XIS\PP000XMP.001
$$$ GEOPAK Program Name : SingleTests
$$$ GEOPAK Part Name : SingleTests
$$$
$$$
DMISMN/'SingleTests',04.0
FILNAM/'SingleTests',04.0
PRCOMP/ON
MODE/MAN
DECL/GLOBAL,CHAR,64,Label_Var[20]
DECL/GLOBAL,REAL,Geopak_Var[20]
UNITS/MM,ANGDEC
DECL/ALL,3
RECALL/SA[S1]
SNSLCT/SA[S1]
RECALL/DA[1]
GEOALG/CIRCLE.LSTSOR
F[Cir_1]=FEAT/CIRCLE,INNER,CART,0.000,0.000,0.000,0.0,1,10.000
MEAS/CIRCLE,F[Cir_1],4
PTMFA&N'DART 5.000 0.000 0.000 -1.000 0.000 0.000
ASCII translation finished
1 $$$ ----- GEOPAK ASCII Part Program -----
2 FILNAM/'AK_0017909_B_1'
3 UNITS/MM
4 ANGUNITS/ANGDEC360
5 DECUNITS/ANGCOS
6 FDP/5
7 CNCON/MESVEL=DEFAULT,POSVEL=DEFAULT,APPROCH=1.5
8 DATSET/MCS
9 RECALL/DA,1
10 $$$ -----
11 $$$ TRANSLATED BY DMISOUT V3.0.0, BUILD DATE: 10/25/05
12 $$$ FROM MCOSMOS V3.0 MITUTOYO CORPORATION
13 $$$
14 $$$ TRANSLATED DATE/TIME : 11/22/05 11:02
15 $$$ GEOPAK INPUT FILE : D:\MITUTOYO\MCOSMOS\DATA\PV5N7XIS\PP000XMP.001
16 $$$ GEOPAK PROGRAM NAME : SINGLETESTS
17 $$$ GEOPAK PART NAME : SINGLETESTS
18 $$$ -----
19 $$$
20 TEXT/OUTFIL,'FILNAM/'SINGLETESTS',04.0'
21 TEXT/OUTFIL,'PRCOMP/ON'
22 CNCOFF
23 FDP/3
  
```

Pure DMISPAK means:

- The reading in and conversion of DMISPAK measurement programs and their execution under MCOSMOS
- Conversion and outputting of MCOSMOS measurement programs in DMIS format

ROUNDPAK CMM, the roundness testing module. Specialising in large workpieces.

ROUNDPAK CMM is the roundness testing module within the MCOSMOS concept and supplements the GEOPAK geometry module. It has been specially designed to test roundness and cylindricity in combination with GEOPAK. ROUNDPAK CMM makes available calculation results and many graphic evaluations for circles, cylinders, flat surfaces and straight lines for integration into user-defined reports.

Examples of graphic evaluations:

Roundness, top view and development

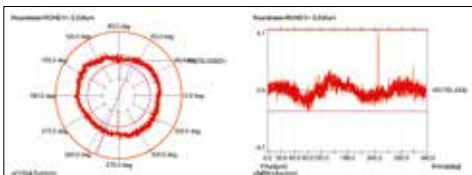

Cylindrical form, solid representation and topographical representation (development)

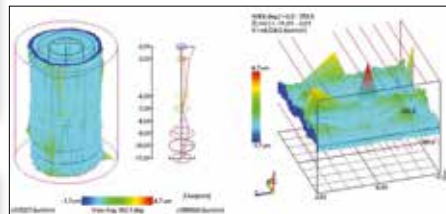

Cylindrical form, spatial representation and side view

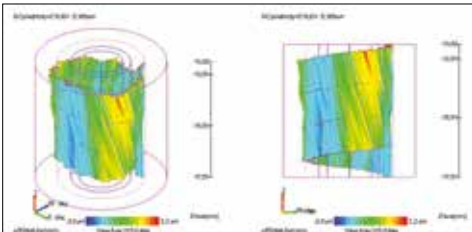

Flat surface, top view, spatial representation and development

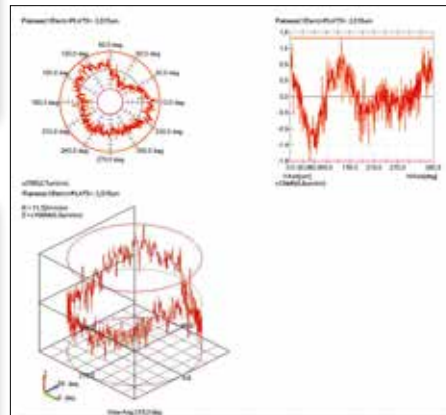

Cylindrical form, top view and developments of several individual elements

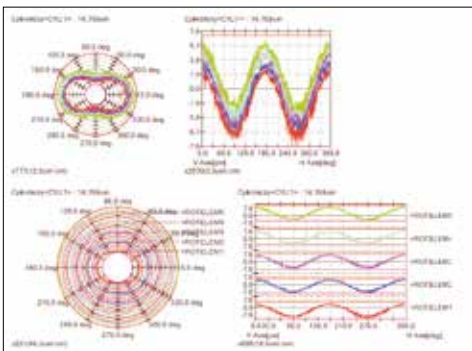

ROUNDPAK CMM means:

- Extended evaluation functions for circles, cylinders, flat surfaces and straight lines.
- Evaluations of the following parameters: rectangularity, cylindrical form, parallelism, concentricity, complete run, circularity, axial runout, straightness, flatness and roundness.

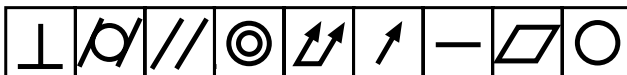

ProtocolDesigner, the form creation tool. Individual reporting, informative documenting.



With the ProtocolDesigner – a standard tool within MCOSOMOS – you can effortlessly draw up new, personalised forms for the GEOPAK, CAT1000S, MAFIS and ROUNDPAK CMM modules, or adapt existing forms to your personal requirements. The standard report becomes a flexible report and you can create the perfect models for basic pages, first and subsequent pages. For the graphic implementation of your own ideas, there is a wide range of variables, fields, tables and graphs available. You will be helped by an assistant, detailed documentation and detailed online help.

Create with ProtocolDesigner, for example, headings with your company logo and setpoint/actual value comparisons in colourful images, or define new levels and enhance your reports with info-flags.

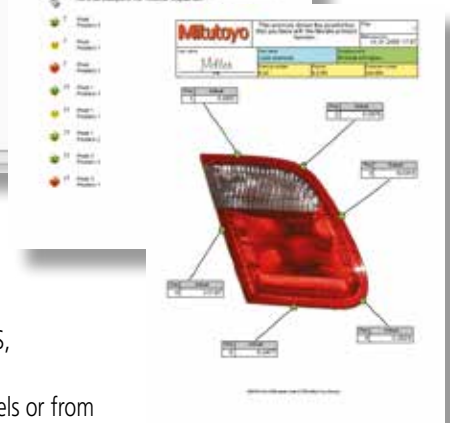
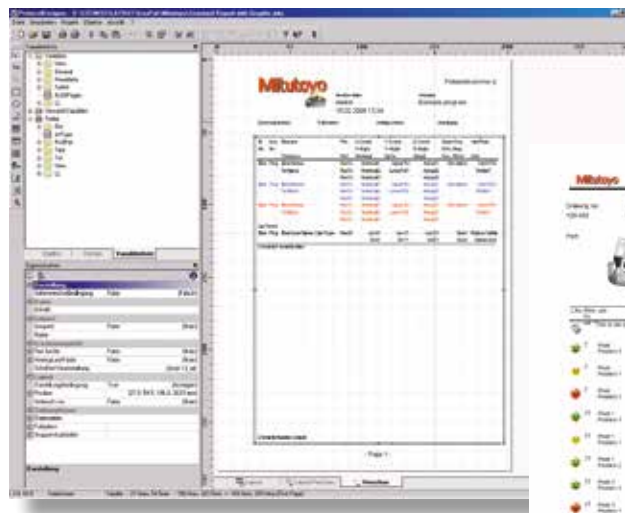

ProtocolDesigner means:

- Personalised form creation for GEOPAK and CAT1000S, SCANPAK, MAFIS and ROUNDPAK CMM
- Incorporation of images from photographs, CAD models or from element graphs
- Easy Excel exports (even where Excel is not installed on your own system)
- Text exports into a CSV file (text-based table format)
- TIFF and multi-TIFF export
- PDF export (128 bit coding)
- ANSI or ASCII export
- HTML/MHTML export
- JPG, BMP and EMF export

Correct Plus, the NC compensation value module. Direct dialogue for lightning reactions.

The rapid feedback of measured data to processing centres is possible with 'Correct Plus' evaluation software. It enables immediate online correction of processes, continuously or randomly checked by a coordinate measuring machine. By contrast with conventional correction by machine or workpiece parameters only – referring to the entire processing program – online correction permits each individual characteristic to be taken into account, for example, position and diameter of holes.



Correct Plus stands for:

- Entry of the calculated correction values in the correction values file
- A correction values file is immediately transferred to ensure that the corrected data are already used by the tool machine control unit for the next work piece
- Shortened running-in times for new process flows
- Quicker transition from 100 percent measurements to random testing thanks to rapid stabilization of processes
- Automatic analysis of measurement results, calculation of new tool correction data and creation of correction databases, directly and without any loss of time
- Correction to average tolerance significantly reduces process errors
- Can be tied in to all commonly used control units
- No interference with the tool machine's NC program

Ask for the separate Correct Plus prospectus with more detailed information: info@mitutoyo.eu



MeasurLink®, the statistical evaluation module. Evaluation, visualisation, process control.



MeasurLink is, for Mitutoyo users, the epitome of perfect measured data management, analysis and storage, giving comprehensive statistical evaluation of your measurements. As the 'analysis' component of the Mitutoyo expansion modules, this program is the tool you use to set out and compare your results. MeasurLink is therefore the ideal software for statistical process control, identifying trends and giving the opportunity to take action before the process exceeds preset intervention limits. As with all measurement programs, this is a multi-tasking-capable tool that can run in the background. Particular emphasis is given to simple, clear user-guidance. The dialogue fields can be flexibly arranged to your own requirements. MeasurLink is largely network-capable. Its resources are independent of the measuring device location and can be used all over the world on any authorised computer. Finally: MeasurLink supports, in addition to Coordinate Measuring Machines, all other digital Mitutoyo measuring equipment right through to dial and calliper gauges.

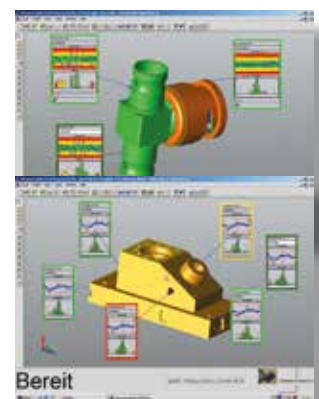
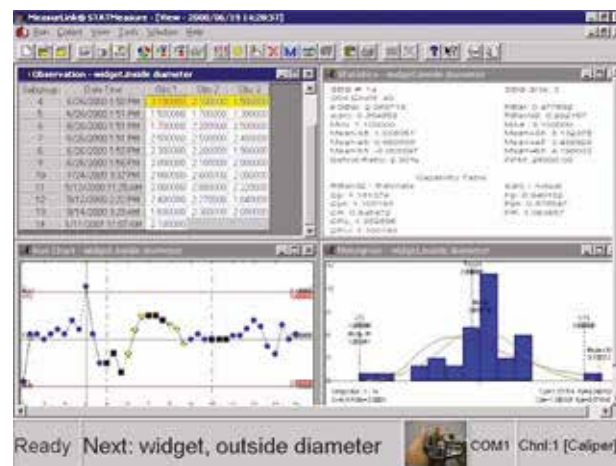

MeasurLink means:

- Optimum configuration with modular program structure
- Real-time control card representation
- Monitoring of various measuring stations in network operation (hall plan, internal/external networks)
- Monitoring of test characteristics from GEOPAK, QVPAK, QSPAK, QIPAK, FORMPAK, ROUNDPAK, SURFPAK and FORMTRACEPAK
- Combination of measured data from all Mitutoyo measuring machines
- Clear tables, graphs and evaluations
- Availability of test equipment control and monitoring and test-equipment capability checks using an add-on module

Request the separate MeasurLink brochure with more detailed information: info@mitutoyo.eu

Q-PAK – the queuing program

Extension module for:

MCOSMOS 1

MCOSMOS 2

MCOSMOS 3

Q-PAK is an easy to operate and intelligent means of controlling the measuring sequence of the next work pieces in line for measurement – ideal for controlling and making full use of the coordinate measuring machine without interruptions.

Where appropriate, Q-PAK also assumes responsibility for controlling semi-automatic or fully automatic loading and unloading systems. Q-PAK blocks unauthorized access to the measurement programs and thus prevents unintentional or unauthorized modifications of the same.

A barcode scanner can be used to quickly and correctly select the part program and enter the sub-batch information for statistical measurement data recording.

The list of last measurements is color coded to allow the state of these measurements to be identified at a glance.

Using a touch screen for the Q-Pak menu together with a barcode scanner enables full use of the program without the need for a keyboard and mouse; ideal for rough manufacturing environments.

Basically it meets all preconditions for secure and simple control of the coordinate measuring machine system during operator self-tests or simply for sequence control during unmanned shifts.



The benefits of Q-PAK:

- Simple and secure part program selection
- Control of the measuring sequence for several work pieces
- Supports barcode scanners
- Activates loading and unloading systems
- System for identifying users can be selected (PIN code, barcode cards, magnetic cards, chip code systems, etc.)
- List of last measurements displayed with status color coded
- Direct access to complete test reports (PDF format) relating to last measurements



KOMEG FixtureBuilder

Standard module for: **MCOSMOS 1** **MCOSMOS 2** **MCOSMOS 3**

KOMEG FixtureBuilder quickly and easily creates the necessary virtual CAD models of the clamping fixtures needed for the work pieces. FixtureBuilder accesses the CAD libraries of the KOMEG eco-fix components and helps to compile the fixtures at the click of a mouse. Users can choose whether to set the virtual fixture up manually or to allow the software's "AutoMode" to perform the task.

Once the tensioning fixture is fully assembled, a CAD model is available that can be used to generate the required measuring programs in the subsequent offline programming and simulation using MCOSMOS under CAT1000.

The list function quickly reveals whether the required tensioning elements already exist or first need to be procured, long before the work piece is physically available.

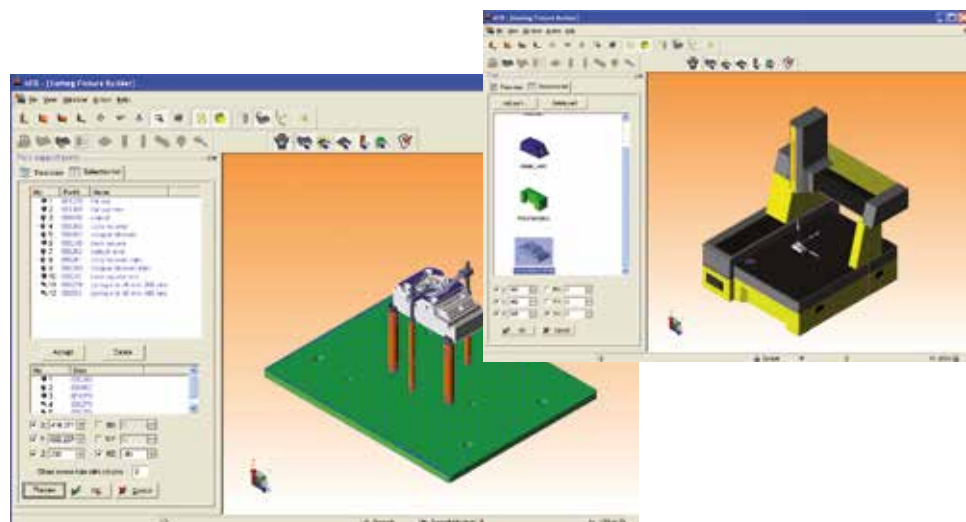

KOMEG FixtureBuilder stands for:

- Quick and easy compilation of tensioning elements
- Supports KOMEG eco-fix elements
- Automatic listing of used components
- Provides the CAD model for CAT1000 offline programming
- Work piece import interfaces: ACIS (*.sat), Iges (*.igs) and Step (*.stp)
- Export functions: Hoops file (*.hsf), Autodesk (*.dwf), 3-D PDF (*.pdf) and ACIS Files (*.sat)
- For use with MCOSMOS V3.1 or higher



**Whatever your challenges are,
Mitutoyo supports you from start to finish.**

Mitutoyo is not only a manufacturer of top quality measuring products but one that also offers qualified support for the lifetime of the equipment, backed up by comprehensive services that ensure your staff can make the very best use of the investment.

Apart from the basics of calibration and repair, Mitutoyo offers product and metrology training, as well as IT support for the sophisticated software used in modern measuring technology. We can also design, build, test and deliver bespoke measuring solutions and even, if deemed cost-effective, take your critical measurement challenges in-house on a sub-contract basis.

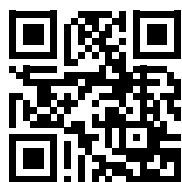

**Find additional product literature
and our product catalogue**

www.mitutoyo.eu

Note: All information regarding our products, and in particular the illustrations, drawings, dimensional and performance data contained in this printed matter as well as other technical data are to be regarded as approximate average values. We therefore reserve the right to make changes to the corresponding designs, dimensions and weights. The stated standards, similar technical regulations, descriptions and illustrations of the products were valid at the time of printing. In addition, the latest applicable version of our General Trading Conditions will apply. Only quotations submitted by ourselves may be regarded as definitive.

Mitutoyo

Mitutoyo Europe GmbH

Borsigstraße 8-10
41469 Neuss

Tel. +49 (0) 2137-102-0
Fax +49 (0) 2137-102-351

info@mitutoyo.eu
www.mitutoyo.eu